

DKLFA30110-2RS [↗](#)

推力角接触球轴承

角接触球轴承单元DKLFA.-2RS，双向，螺栓安装，两侧唇式密封，平面法兰

技术信息

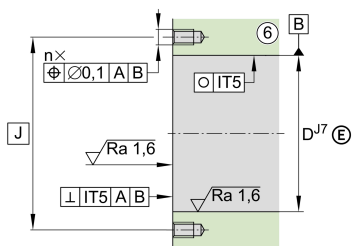
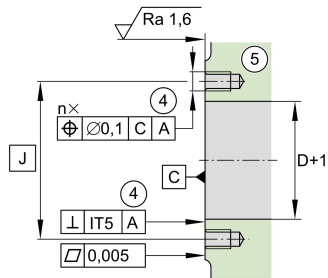
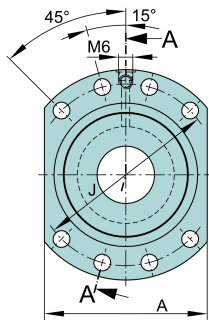
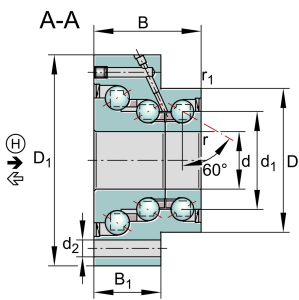

您当前的产品型号

密封	2RS	两侧接触唇式密封
----	-----	----------

主要尺寸和性能数据

d	30 mm	内径
	0 mm	螺母直径，上偏差
	-0.01 mm	螺母直径，下偏差
D	75 mm	外径
	0 mm	外径，上偏差
	-0.013 mm	外径，下偏差
B	56 mm	宽度
	0 mm	宽度，上偏差
	-0.25 mm	宽度，下偏差
C _a	107,000 N	Basic dynamic load rating, axial HL
C _a	59,000 N	基本额定动载荷, 轴向
C _{0a}	255,000 N	Basic static load rating, axial HL
C _{0a}	108,000 N	基本额定静载荷, 轴向
C _{ua}	6,600 N	Fatigue load limit, axial HL
C _{ua}	4,800 N	疲劳极限载荷, 轴向
n _{G Grease}	3,500 1/min	脂润滑极限转速
n _g	1,600 1/min	热许用转速
≈m	2.087 kg	重量

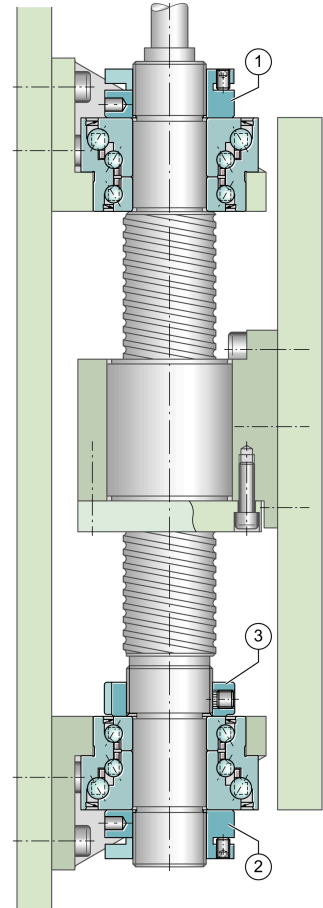
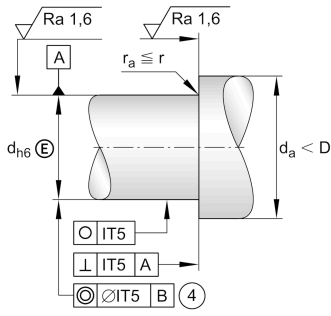

安装尺寸

$d_{a \min}$	47 mm	轴挡肩最小直径
$d_{a \max}$	64 mm	轴挡肩最大直径
	M8	螺栓尺寸
n	8	螺栓数量

尺寸

d_1	51 mm	内圈挡边直径
D_1	110 mm	法兰直径
r_{\min}	0.3 mm	最小倒角尺寸
$r_{1 \min}$	0.6 mm	最小倒角尺寸
B_1	35 mm	法兰厚度
d_2	8.8 mm	固定孔直径
J	95 mm	节圆直径 (孔)
A	85 mm	法兰宽度

温度范围







T_{\min}	-30 °C	最低工作温度
T_{\max}	120 °C	最高工作温度



附加信息

M_{RL}	1.5 Nm	轴承摩擦力矩
c_{aL}	1,300 N/ μ m	轴向刚度
c_{aL}	1,600 N/ μ m	Rigidity axial (HL)
c_{kL}	650 Nm/mrad	倾斜刚度
	5 μ m	轴向跳动
M_m	3.23 kg*cm ²	惯性力矩
(3) r	ZM35	Recommended INA precision locknut for radial locking 3
(1), (2) r	AM30/65	Recommended INA precision locknut for axial locking 1,2
M_A	65 Nm	螺母拧紧力矩
(1), (2) a	20,500 N	Required locknut force axial 1

特点

-  径向载荷
-  单向的轴向载荷
-  双向的轴向载荷
-  终身润滑，免维护
-  脂润滑
-  双侧密封